

SMALL FITTINGS FOR FURNITURE

PEQUEÑO ACCESORIO
PETIT ACCESSOIRES

CABINET SUPPORTS

SOPORTE PARA MUEBLES
SUPPORTS POUR MEUBLE

SCREWS CONCEALMENT

OCULTACIÓN DE TORNILLO
CACHE-VIS

MIRROR SCREW-CAP AND HOLDERS

SUJECIÓN DE ESPEJOS
PÂTTES À GLACE

WARDROBE TUBE-SUPPORTS

SOPORTES DE TUBO ARMARIO
SUPPORTS TRINGLES PENDERIE

CONNECTING SYSTEMS

ELEMENTOS DE UNIÓN
ÉLEMENTS D'UNION

LIFT & OTHERS

AMORTIGUADORES Y VARIOS
VÉRINS ET DIVERS

FURNITURE LOCKS

CIERRES Y CERRADURAS PARA
MUEBLE
SERRURES DE MEUBLES

TRANSPARENT BLISTERS

ENVASES TRANSPARENTES
COQUES TRANSPARENT



CATALOG / CATÁLOGO / CATALOGUE

INTERNATIONAL DESIGN AWARDS
PREMIOS INTERNACIONALES DE DISEÑO
PRIX INTERNATIONAUX DE DESIGN



Good Design Award 2017
The Chicago Athenaeum Museum of
Architecture and Design

All product designs contained in this catalog are exclusive of Reunión Industrial S.L.U. The trade-marks and logos are registered and they are property of REI

Los diseños que contiene este catálogo son exclusivos de Reunión Industrial S.L.U. Las marcas comerciales y logotipos utilizados están registrados y son propiedad de REI

Les designs que ce catalogue contient sont exclusifs à la société Reunión Industrial S.L.U. Les marques commerciales et logotypes utilisés sont enregistrés et sont la propriété de la société REI

REUNIÓN INDUSTRIAL

The history of REI and the history of the manufacture of decorative fittings, furniture components and DIY accessories in Spain have run parallel to each other since 1986. Those histories converged when REI, by its very nature, began to lead the sector, incorporating continuous improvement processes and implementing a quality management system for the optimisation of the production process (ISO 9001 certified by SGS). Leadership is reinforced by integrating sustainability as a value present in materials and production processes, from design, prototyping, mould making, casting and metal turning, to packaging. REI applies a dynamic and integral discipline of sustainability to the entire production process; a recognised policy of environmental preservation that has allowed it, among other things, to obtain the demanding PEFC certification (Programme for the Endorsement of Forest Certification).

La historia de la fabricación de herrajes decorativos, complementos de mobiliario y accesorios DIY, en España y la de REI, transcurren en paralelo desde 1986 hasta que, por su propia naturaleza, REI, comienza a liderar el sector, incorporando procesos de mejora continua e implementando un sistema de gestión de la calidad para la optimización del proceso productivo (Norma ISO 9001 certificada por SGS). El liderazgo se consolida al integrar la sostenibilidad como un valor presente en materiales y procesos de producción, desde el diseño, el prototipado, la confección de moldes, la fundición y el torno de metal, hasta el envasado. REI aplica una disciplina dinámica e integral de sostenibilidad a todo el proceso productivo; una reconocida política de preservación medioambiental que le ha permitido, entre otras cosas, obtener la exigente certificación PEFC (Programme for the Endorsement of Forest Certification).

L'histoire de la fabrication de ferrures décoratives, de compléments de meubles et d'accessoires DIY en Espagne, et celle de REI, s'écrivent en parallèle depuis 1986 jusqu'à ce que, de manière intrinsèque, REI commence à être à la tête du secteur, en incorporant des processus d'amélioration continue et en mettant en place un système de gestion de la qualité pour l'optimisation du processus de production (Norme ISO 9001 certifiée par SGS). Le leadership est consolidé en intégrant la durabilité en tant que valeur actuelle dans les matériaux et les processus de production, depuis la conception, le prototypage, la fabrication de moules, la fusion et le tournage de métaux, jusqu'à l'emballage. REI applique une discipline dynamique et intégrale de durabilité à l'ensemble du processus de production ; une politique reconnue de préservation de l'environnement qui lui a permis, entre autres, d'obtenir l'exigente certification PEFC (Programme for the Endorsement of Forest Certification).



REI TAKES CARE OF ENVIRONMENT
REI CON EL MEDIO AMBIENTE
NOUS RESPECTONS L'ENVIRONNEMENT



REI COOPERATES WITH THE FOLLOWING INSTITUTIONS
REI TRABAJA EN COLABORACIÓN CON LAS SIGUIENTES INSTITUCIONES
REI TRAVAILLE EN COLLABORATION AVEC LES INSTITUTIONS SUIVANTES



WELCOME

BIENVENIDO / BIENVENUE

THANK YOU

FOR CHOOSING US

Each and every one of us is responsible for offering you, to the same extent, the range of products available in this catalogue.

We would like to thank you for counting on us as part of your company project.

GRACIAS

POR CONTAR CON NOSOTROS

Todos y cada uno de nosotros somos responsables de ofrecerte, en la misma medida, la gama de productos dispuesta en este catálogo. Queremos agradecerle que cuente con nosotros como parte de su proyecto de empresa.

MERCI

POUR VOTRE CONFIANCE

Chacun de nous s'engage sans exception à vous fournir toute la gamme des produits présents sur ce catalogue. Nous souhaitons vous remercier pour compter sur nous comme une partie de votre projet d'entreprise.



WITH YOU
SINCE

1986

CONTIGO DESDE / AVEC VOUS DEPUIS

You are entering Reunión Industrial, welcome to the Spanish decorative fitting and furniture accessories manufacturing company with the greatest international projection.

A team of over one hundred people is behind the company that is present in 45 countries. Together, we have managed to turn our company into an international benchmark for quality and sustainability, thanks to our total environmental commitment to build the future by using our business activity for the benefit of all.

What you are about to see, from here on in, is the result of more than thirty years of evolution. A range of products consistent with our design and sustainability criteria, which will allow us to strengthen the mutual relationship.

Thanks for joining us.

Estás entrando en Reunión Industrial, bienvenido a la empresa española de fabricación de herrajes decorativos y complementos de mobiliario con mayor proyección internacional.

Un equipo, de más de cien personas, estamos detrás de REI y REI tiene presencia en 45 países.

Juntos, hemos conseguido convertir nuestra empresa en referente internacional de calidad y sostenibilidad, gracias a nuestro absoluto compromiso medioambiental para construir el futuro aportando nuestra actividad empresarial en beneficio de todos.

Lo que vas a ver, de ahora en adelante, es el resultado de más de treinta años de evolución. Una gama de productos coherente con nuestros criterios de diseño y sostenibilidad, que permitirán afianzar la relación mutua.

Gracias por unirse a nosotros.

Vous entrez dans Reunión Industrial, bienvenue chez l'entreprise espagnole qui fabrique des ferrures décoratives et des accessoires pour meubles avec la plus grande projection internationale.

Une équipe de plus de cent personnes qui est à l'origine de REI et REI est présente dans 45 pays.

Ensemble, nous avons réussi à faire de notre entreprise une référence internationale en matière de qualité et de durabilité. Grâce à notre engagement environnemental absolu, nous construisons l'avenir en apportant notre activité commerciale au bénéfice de tous.

Ce que vous allez voir, désormais, est le résultat de plus de trente ans d'évolution. Une gamme de produits conformes à nos critères de conception et de durabilité, ce qui nous permettra de consolider la relation mutuelle.

Merci de vous joindre à nous.



MADE IN
SPAIN

FABRICADO EN ESPAÑA / FABRIQUÉ EN ESPAGNE

+30

YEARS OF EXPERIENCE
AÑOS DE EXPERIENCIA
ANS D'EXPERIENCE

+5000

CUSTOMERS
CLIENTES
CLIENTS

45

COUNTRIES
PAÍSES
PAYS

+3500

REFERENCES
REFERENCIAS
RÉFÉRENCES

+300

NOVELTIES/YEAR
NOVEDADES/AÑO
NOUVEAUTÉS/AN

+100

EMPLOYEES
EMPLEADOS
EMPLOYÉS

95%

SERVICE
TASA DE SERVICIO
TAUX DE SERVICE

HOW TO INTERPRET THE CATALOG

CÓMO INTERPRETAR EL CATÁLOGO / COMMENT INTERPRÉTER LE CATALOGUE

BARCODE NUMBER

CÓDIGO DE BARRAS
CODE À BARRES

REFERENCE FOR ORDER
REFERENCIA PARA PEDIDO
RÉFÉRENCE POUR COMMANDE

7- 891.128.29

TYPE OF PACKAGING
TIPO DE ENVASADO
TYPE DE CONDITIONNEMENT

7- **891**.128.29

PRODUCT NAME
NOMBRE DEL MODELO
NOM DU PRODUIT

7-891. **128** .29

MAIN SIZE
MEDIDA PRINCIPAL
DIMENSION PRINCIPALE

7-891.128. **29**

FINISH
ACABADO
FINITION

PACKAGING QUANTITY
CONDICIONAMIENTO
CONDITIONNEMENT

FINISH
ACABADO
FINITION

BARCODE NUMBER
CÓDIGO DE BARRAS
CODE À BARRES

MATERIAL
MATERIAL
MATIÈRE

TYPE OF PACKAGING
TIPO DE ENVASADO
TYPE DE CONDITIONNEMENT

SECTION TITLE
TÍTULO DE SECCIÓN
TITRE DE SECTION

PRODUCT NAME
NOMBRE DEL MODELO
NOM DU PRODUIT

TECHNICAL CHARACTERISTICS
CARACTERÍSTICAS TÉCNICAS
CARACTÉRISTIQUES TECHNIQUES

OTHER OPTIONAL PACKAGING TYPES
OTROS ENVASADOS OPCIONALES
D'AUTRES OPTIONS DE CONDITIONNEMENT

PRODUCT PICTURE
IMAGEN DE PRODUCTO
IMAGE DU PRODUIT

CONTEMPORARY / CONTEMPORÁNEO / CONTEMPORAIN

METALLIC · METÁLICO · METALLIQUE

5011 | 5012

128 145 28 18 **5011.128**
160 177 28 18 **5011.160**

30 25 30 **5012**

186 110 23 2x **32N-5011**
186 160 23 4x **34N-5011**
93 110 25 2x **32N-5012**
93 160 25 4x **34N-5012**



34N-5011.128.334	8423224871430	6	7-5011.128.321	8423224866743	10
7-5011.128.322	8423224865729	10	7-5011.128.334	8423224866762	10
7-5011.128.934	8423224865682	10	7-5011.128.940	8423224865712	10
34N-5012.322	8423224871423	6	7-5011.160.321	8423224865750	10
7-5011.160.322	8423224865736	10	7-5011.160.334	8423224865774	10
7-5011.160.934	8423224865699	10	7-5011.160.940	8423224865712	10
7-5012.322	8423224866781	10	7-5012.934	8423224865804	10
7-5012.940	8423224866798	10	32N-5011.128.334	8423224871614	6
32N-5011.128.334	8423224871614	6	32N-5011.128.940	8423224895962	6
32N-5012.934	8423224881521	6	32N-5012.940	8423224871677	6

TYPES OF PACKAGING

TIPOS DE ENVASADO / TYPES DE CONDITIONNEMENTS



2- TO BE HANGED
ARTÍCULO COLGABLE
ARTICLE À PENDRE

32- TO BE HANGED
ARTÍCULO COLGABLE
ARTICLE À PENDRE

34- TO BE HANGED
ARTÍCULO COLGABLE
ARTICLE À PENDRE



6- 6 PC PROMOTIONAL POLIBAG
EMBOLSADO PROMOCIONAL 6 U.
SACHET PROMOTIONNEL 6 P.

7- RETAIL POLYBAG WITH BARCODE
EMBOLSADO TIENDA CON CÓDIGO DE BARRAS
SACHET MAGASIN AVEC CODE BARRES

TP- 2 PC PROMOTIONAL POLIBAG
TWIN-PACK EMBOLSADO PROMOCIONAL 2 U.
TWIN-PACK SACHET PROMOTIONNEL 2 P.



5- PRODUCT WITH BARCODE
PRODUCTO CON CÓDIGO DE BARRAS
PRODUIT AVEC CODE À BARRES

1- INDUSTRIAL PACKAGING WITHOUT BARCODE
EMBOLSADO INDUSTRIAL SIN CÓDIGO DE BARRAS
SACHET INDUSTRIEL SANS CODE BARRES

INDEX

ÍNDICE / INDEX



SMALL ACCESSORIES FOR FURNITURE / PEQUEÑO ACCESORIO PARA MUEBLE / PETIT ACCESSOIRES POUR MEUBLES

- | | |
|---|---|
| 15 Cabinet supports
<i>Soportes para muebles</i>
<i>Supports pour meuble</i> | 23 Connecting systems
<i>Elementos de unión</i>
<i>Élements d'union</i> |
| 19 Screws concealment
<i>Ocultación del tornillo</i>
<i>Cache-vis</i> | 25 Lift & others
<i>Amortiguadores y varios</i>
<i>Vérins et divers</i> |
| 21 Mirror screw-caps and holders
<i>Sujeción de espejos</i>
<i>Pâtes à glace</i> | 25 Furniture locks
<i>Cierres y cerraduras para mueble</i>
<i>Serrures de meubles</i> |
| 22 Wardrobe tube-supports
<i>Soportes de tubo armario</i>
<i>Supports tringles penderie</i> | 26 Transparent blisters
<i>Envases transparentes</i>
<i>Coques transparent</i> |

NAIL-IN PLASTIC SUPPORT / TOPE PLÁSTICO 2 PUNTAS / BUITOIRS À CLOUER

6

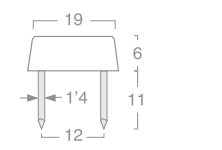

130	142	23	100u.
64	96	21	16u.



PL	01	09
7-6.01	8423224812181	5
2-6.01	8423224792698	5
	8423224792704	5

7

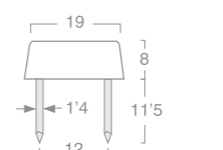

130	150	24	100u.
64	96	21	16u.

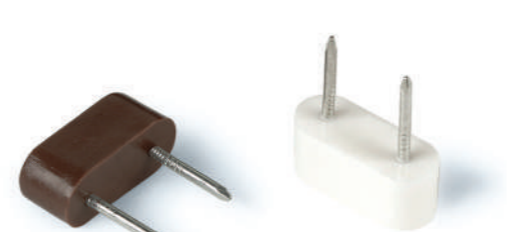

PL	01	09
7-7.01	8423224812211	5
	8423224812228	5
2-7.01	8423224792711	5
	8423224792728	5

28

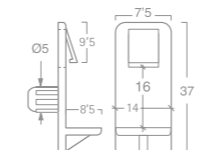

135	130	48	100u.
64	96	21	4u.



PL	80	
7-28.80	8423224820162	5
2-28.80	8423224793152	5



NAIL-IN PLASTIC SUPPORT / SOPORTE PLÁSTICO CON CLAVO / SUPPORTS À CLOUER

37

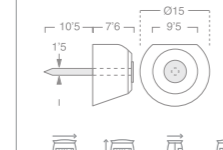

130	145	17	100u.
64	96	21	18u.



PL	01	09
7-37.01	8423224820179	5
2-37.01	8423224792841	5
	8423224792858	5



DOWEL PLASTIC SUPPORT / SOPORTE PLÁSTICO HEMBRILLA / SUPPORT À DOWEL

10

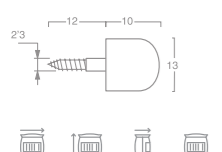

130	145	15	100u.
64	96	21	16u.



PL	01	09
7-10.01	8423224812112	5
	8423224812129	5
2-10.01	8423224792759	5
	8423224792766	5

11

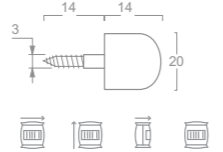

145	250	25	100u.
64	96	21	12u.

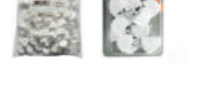

PL	01	09
7-11.01	8423224812136	5
	8423224812143	5
2-11.01	8423224792773	5
	8423224792780	5

METAL PIN PUSH-IN SUPPORT / SOPORTE PLÁSTICO PIN METAL / SUPPORT PLASTIQUE À TIGE MÉTALIQUE

93

Ø3mm_Ø5mm

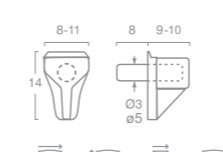

130	145	20	100u.
64	96	21	16u.



AC	PL	01	80
7-93.3.80	8423224820322	5	
	8423224820315	5	
2-93.3.80	8423224792865	5	
	8423224792872	5	
	8423224792889	5	



PLUG-IN METAL SUPPORT / SOPORTE EMBUTIBLE METÁLICO / SUPPORT MÉTALLIQUE ENCASTRÉ

83

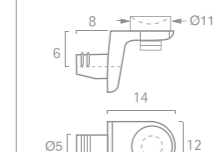

64	96	21	4u.

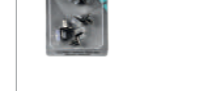

Z	54	
2-83.54	8423224793473	5



PUSH-IN ANGLE SUPPORT / SOPORTE PLÁSTICO ESCUADRA / SUPPORT ANGLE PLASTIQUE

9

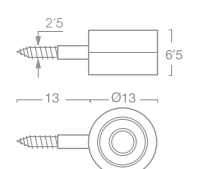

130	145	14	100u.

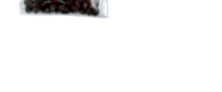

PL	01	09
7-9.01	8423224812235	5
	8423224812242	5

227

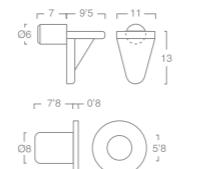

64	96	21	16u.



PL	01	09
2-227.01	8423224792797	5
	8423224792803	5

METAL SUPPORT WITH SUCTION CUP / SOPORTE METÁLICO CON VENTOSA / SUPPORT MÉTALLIQUE AVEC VENTOUSE

90

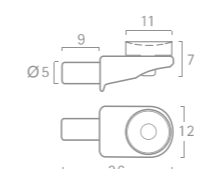

64	96	21	8u.



Z	53	54
2-90.53	8423224793497	5
	8423224793503	5



91

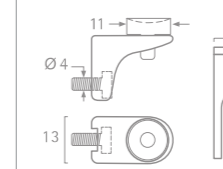

64	96	21	4u.



Z	54	
2-91.54	8423224793527	5



**ADJUSTABLE
REGULABLE
RÉGLABLE**

SMALL FITTINGS / PEQUEÑO ACCESORIO / PETIT ACCESSOIRES

CABINET SUPPORTS / SOPORTE PARA MUEBLES / SUPPORTS POUR MEUBLE



SUCTION CUP / VENTOSA / VENTOUSE

184

PL 80

2-184.80 8423224793480 5

64 96 21 20u.

METAL ANGLE SUPPORT / SOPORTE METÁLICO ESCUADRA / SUPPORT ANGLE MÉTALLIQUE

92

Z 54

7-92.54 8423224820261 5

2-92.54 8423224793534 5

130 145 20 100u.

64 96 21 12u.

DOWEL BRASS SUPPORT / SOPORTE LATÓN / SUPPORT LAITON À DOWEL

100

L 53

2-100.53 8423224792896 5

64 96 21 6u.

PUSH-IN SCREW-CAP / TAPÓN EMBUTIBLE PARA TORNILLO / CACHE-VIS

52

PL 01 09

2-52.01 8423224812310 5

2-52.09 8423224812327 5

64 96 21 25u.

PLUG-IN BRASS SUPPORT / SOPORTE EMBUTIBLE LATÓN / SUPPORT EN LAITON ENCASTRÉ

101

L 53

2-101.53 8423224792902 5

64 96 21 6u.

SHELF SUPPORT + KNOCK-IN SOCKET
SOPORTE + CASQUILLO
SUPPORT MÉTALLIQUE + DOUILLE

PLUG-IN STEEL SUPPORT / SOPORTE EMBUTIBLE ACERO / SUPPORT EN ACIER ENCASTRÉ

221

AC 53

2-221.53 8423224792919 5

64 96 21 8u.

PLUG-IN METAL SUPPORT / SOPORTE EMBUTIBLE METÁLICO / SUPPORT MÉTALLIQUE ENCASTRÉ

26

AC 53 54 55

7-26.53 8423224820339 5

7-26.54 8423224820346 5

2-26.53 8423224792810 5

2-26.54 8423224792827 5

2-26.55 8423224792834 5

130 145 10 100u.

64 96 21 16u.

96

FE 54

7-96.5.54 8423224820308 5

2-96.3.54 8423224793565 5

2-96.5.54 8423224793572 5

130 145 15 100u.

64 96 21 12u.

96.5

96.3

PLYWOOD FOIL / CHAPA PREENCOLADA MELAMINA / PLAQUE MÉLAMINE

4481

01

2-4481.01 8423224003152 8

150 220 25 1u.

4485

01

2-4485.01 8423224003190 8

150 220 25 1u.

2,5 M ROLL
ROLLO DE 2,5 M
ROULEAU DE 2,5 M

5 M ROLL
ROLLO DE 5 M
ROULEAU DE 5 M

SELF-ADHESIVE SCREW CAP / TAPÓN AUTOADHESIVO PARA TORNILLO / CACHE-VIS AUTOCOLLANT

63

Ø12mm_Ø17mm

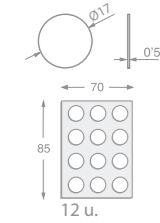
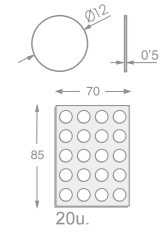

Ø12mm		PVC	
1-63.12.01	8423224631164	1000	
1-63.12.02	8423224631188	1000	
1-63.12.03	8423224631195	1000	
1-63.12.14	8423224631218	1000	
1-63.12.17	8423224631171	1000	
1-63.12.67	8423224759172	1000	
1-63.12.88	8423224759691	1000	
1-63.12.90	8423224631225	1000	
1-63.12.92	8423224631232	1000	
1-63.12.96	8423224868140	1000	
1-63.12.99	8423224868126	1000	
1-63.12.1499	8423224868133	1000	
1-63.12.1797	8423224868164	1000	
1-63.12.8896	8423224868157	1000	

Ø17mm			
1-63.17.01	8423224757772	600	
1-63.17.67	8423224759189	600	
1-63.17.88	8423224759707	600	
1-63.17.92	8423224757840	600	

	01 White Blanco Blanc		03 Black Negro Noir		13 Sapeli Sapeli Sapeli		14 Cream Crema Crème
	02 Grey Gris Gris		17 Off white Blanco Mate Blanc mat		18 Off black Negro Mate Noir mat		67 Aluminium Aluminio Aluminium
	15 Maple Maple Érable		90 Transparent beech Haya l. Transparente Hêtre transparent		91 Walnut Laca nogal / Nogal Noix		92 Light oak Roble claro Chêne clair
	88 Lacquer wenge Laca wengué Laque wengé		94 Pine Pino Pin		96 Natural oak Roble Natural Chêne naturel		98 Cherry tree Hce - Laca cerezo Cerisier
	93 Transparent oak Roble L. Transparente Chêne transparent		1499 Beige linen Lino Beige Lin beige		1797 White Pine Pino Blanco Pin blanc		8896 Oak Wenge Roble Wengué Chêne Wenge
	99 Linen Lino Lin						

4063

Ø12mm_Ø17mm

90	140	4	40u.	Ø12mm
90	140	4	36u.	Ø17mm



Ø12mm			
2-4063.12.01	8423224788844	10	
2-4063.12.02	8423224788868	10	
2-4063.12.03	8423224788875	10	
2-4063.12.13	8423224788981	10	
2-4063.12.14	8423224788899	10	
2-4063.12.15	8423224788974	10	
2-4063.12.17	8423224788851	10	
2-4063.12.18	8423224788882	10	
2-4063.12.67	8423224788905	10	
2-4063.12.88	8423224788998	10	
2-4063.12.90	8423224788912	10	

Ø12mm			
2-4063.12.91	8423224788950	10	
2-4063.12.92	8423224788929	10	
2-4063.12.93	8423224788936	10	
2-4063.12.94	8423224788943	10	
2-4063.12.98	8423224788967	10	
2-4063.12.99	8423224863718	10	
2-4063.12.1499	8423224863701	10	
2-4063.12.1797	8423224863671	10	

Ø17mm			
2-4063.17.01	8423224789001	10	
2-4063.17.02	8423224789025	10	
2-4063.17.03	8423224789032	10	
2-4063.17.13	8423224789148	10	
2-4063.17.14	8423224789056	10	
2-4063.17.15	8423224789131	10	
2-4063.17.17	8423224789018	10	
2-4063.17.18	8423224789049	10	
2-4063.17.67	8423224789063	10	
2-4063.17.90	8423224789070	10	
2-4063.17.92	8423224789087	10	
2-4063.17.93	8423224789094	10	
2-4063.17.94	8423224789100	10	

1063

Ø12mm

96	172	5	100u.
----	-----	---	-------



Ø12mm			
2-1063.12.01	8423224630143	10	
2-1063.12.90	8423224630228	10	
2-1063.12.92	8423224630952	10	

10063

Ø12mm

90	140	4	100u.
----	-----	---	-------



Ø12mm			
2-10063.12.01	8423224863770	4	
2-10063.12.02	8423224863787	4	
2-10063.12.03	8423224863794	4	
2-10063.12.13	8423224863800	4	
2-10063.12.14	8423224863817	4	
2-10063.12.15	8423224863824	4	
2-10063.12.17	8423224863831	4	
2-10063.12.18	8423224863848	4	
2-10063.12.67	8423224863855	4	
2-10063.12.88	8423224863862	4	
2-10063.12.90	8423224863879	4	
2-10063.12.91	8423224863886	4	
2-10063.12.92	8423224863893	4	
2-10063.12.93	8423224863909	4	
2-10063.12.94	8423224863916	4	
2-10063.12.96	8423224863749	4	
2-10063.12.98	8423224863923	4	
2-10063.12.99	8423224863763	4	
2-10063.12.1499	8423224863756	4	
2-10063.12.1797	8423224863725	4	
2-10063.12.8896	8423224863732	4	



SMALL FITTINGS / PEQUEÑO ACCESORIO / PETIT ACCESSOIRES

MIRROR SCREW-CAPS AND HOLDERS / SUJECIÓN DE ESPEJOS / PÂTTES À GLACE



BRASS SCREW-CAP / EMBELLECEDOR LATÓN / CACHE-VIS LAITON

112 | **114** | **116** | **118**
 Ø12mm | Ø14mm | Ø16mm | Ø18mm

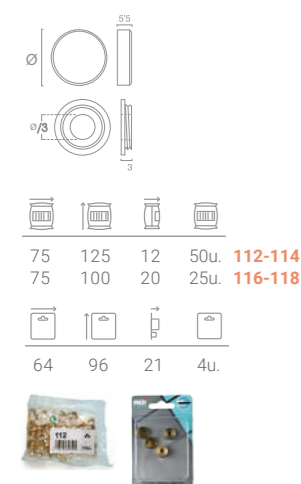

Code	Barcode	Box Qty	Color	Code	Barcode	Box Qty
7-112.21	8423224111178	100	L	2-112.20	8423224793589	5
7-114.21	8423224111192	100	20	2-112.21	8423224793596	5
7-116.21	8423224111215	100	21	2-114.20	8423224793602	5
7-118.21	8423224111239	100		2-114.21	8423224793619	5
				2-116.20	8423224793626	5
				2-116.21	8423224793633	5
				2-118.20	8423224793664	5
				2-118.21	8423224793671	5

MIRROR SCREW CAP / SOPORTE EMBELLECEDOR DE ESPEJOS / PATTE À GLACE



130
2mm_5mm

Ref.130
x= 2-5 mm

Code	Barcode	Box Qty
7-130.21	8423224111338	100
2-130.20	8423224793763	5
2-130.21	8423224793770	5

117

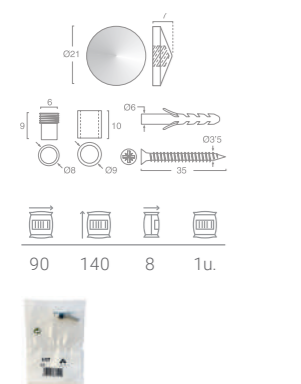

Code	Barcode	Box Qty
7-117.38	8423224760512	50

119

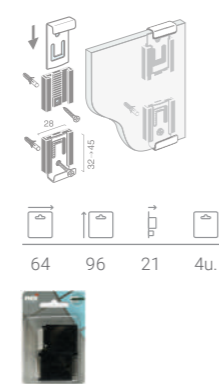

Code	Barcode	Box Qty
2-119.29	8423224793541	5

148

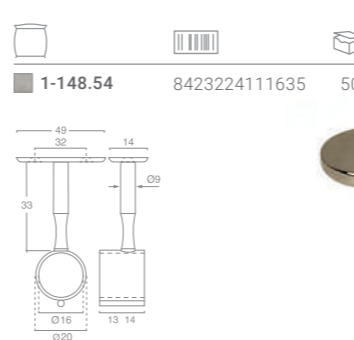

Code	Barcode	Box Qty
1-148.54	8423224111635	50

144

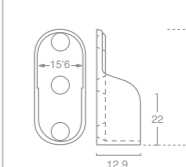

Code	Barcode	Box Qty
1-144.53	8423224110850	100
1-144.54	8423224110867	100

124 | **126**

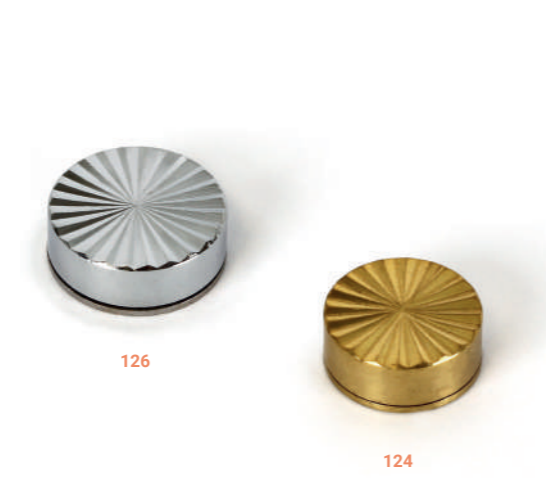
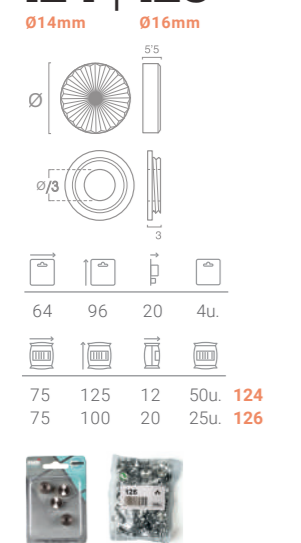

Code	Barcode	Box Qty
7-124.20	8423224111260	100
7-124.21	8423224111277	100
7-126.20	8423224111284	100
7-126.21	8423224111291	100
2-124.21	8423224793718	5

145 | **146**

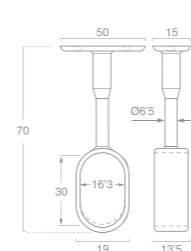

Code	Barcode	Box Qty
1-145.54	8423224110881	50
1-146.54	8423224110904	50

35.05 | 35.08

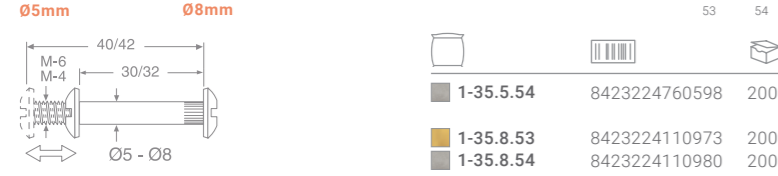

AC	53	54
1-35.5.54	8423224760598	200
1-35.8.53	8423224110973	200
1-35.8.54	8423224110980	200



35.5 Ø5 M4
 35.8 Ø8 M6
 35.8 Ø8 M6

1470

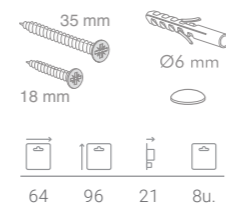

PL	AC	01	18
2-1470.01	8423224788356	5	
2-1470.18	8423224788387	5	

64 96 21 8u.



4406 | 4407 | 4408 | 4409 | 4410 | 4411

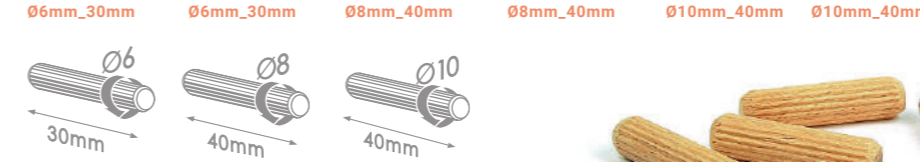

158	162	15	50u.	4406
155	190	35	200u.	4407
155	171	25	40u.	4408
160	215	50	150u.	4409
158	172	30	25u.	4410
156	235	45	120u.	4411



2-4406	8423224002759	10
2-4408	8423224002773	10
2-4410	8423224002797	10
2-4407	8423224002766	5
2-4409	8423224002780	5
2-4411	8423224002803	5

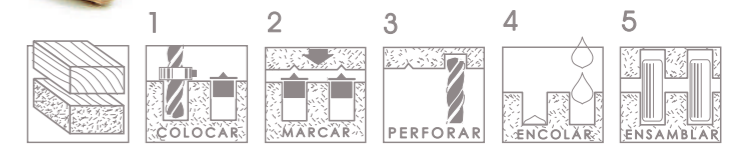

M4 HANDLES SCREW / TORNILLO M4 PARA TIRADORES / VIS M4 POUR POIGNÉES

56

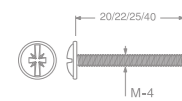

AC	54
1-56.20.54	8423224113301 1000
1-56.22.54	8423224631089 1000
1-56.25.54	8423224111123 1000
1-56.40.54	8423224111154 500



61

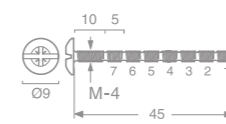

AC	54
7-61.54	8423224812204 25
2-61.54	8423224793169 5

130 140 10 50u.
 64 96 21 20u.



CONNECTING PLASTIC ANGEL / ESCUADRA DE UNIÓN / ANGLE PLASTIQUÉ D'UNION

WOODEN DOWEL / VARILLA ENSAMBLE DE 1 METRO / TIGE D'ASSEMBLAGE

20

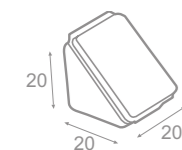

PL	01
1-20.01	8423224820551 160



CT.10

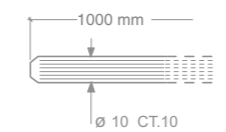

H	95
1-CT.10.95	8423224760581 100



16 | 19

Ø13,5mm Ø16mm

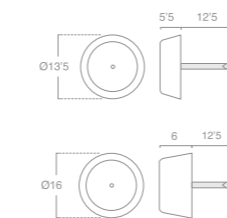

PL	01	09
7-16.01	8423224820100 5	
7-16.09	8423224819548 5	
7-19.01	8423224820117 5	
7-19.09	8423224819555 5	

150 128 15 100u. 16
 130 145 22 100u. 19



19 16

123

Ø30mm

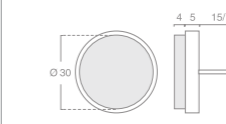

F	PL	09
1-123.30.09	8423224789285 200	



FELT GLIDE / PROTECTOR DE FIELTRO / GLISSANT EN FEUTRÉ

473

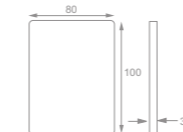

90 140 5 1u.



F	09
2-473.09	8423224790304 10

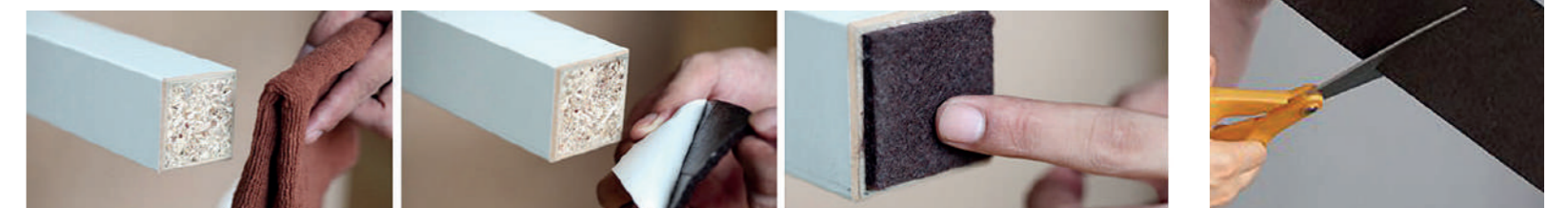

GAS SPRING / ELEVADOR DE GAS / VÉRIN À GAZ

202

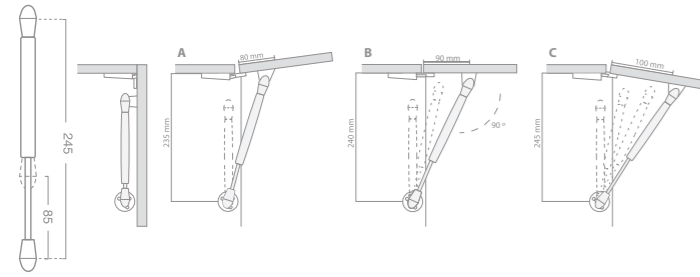

AC PL 38

■ 1-202.38	8423224762073	10
------------	---------------	----



WITH ACCESORIES / CON ACCESORIOS / AVEC ACCESOIRES

- CONNECTOR TO WOODEN DOOR**
Enganche marco de madera
Pièce d'accrochage latérale
- CONNECTOR TO ALUMINIUM-FRAMED DOOR**
Enganches marco de aluminio
Pièce d'accrochage pour encadrement aluminium
- SIDE CONNECTOR**
Enganche lateral
Pièce d'accrochage latérale



FURNITURE LOCKS / CIERRES Y CERRADURAS PARA MUEBLE / SERRURES DE MEUBLES

A

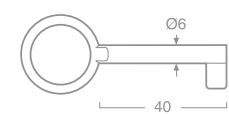

Z 53

■ 7-A.53	8423224810590	30
----------	---------------	----

90	140	6	1u.
----	-----	---	-----



KEY
LLAVE
CLEF

205A

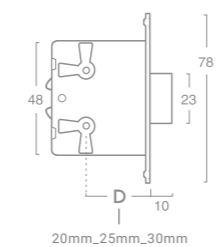

AC

7-205A.20	8423224810323	10
7-205A.25	8423224810330	10
7-205A.30	8423224810347	10

195	90	12	1u.
-----	----	----	-----



KEY "A" INCLUDED_MORTISE LOCK
LLAVE "A" INCLUIDA_EMBUTIR
CLEF "A" INCLUE_À EMBOUTIR

206A

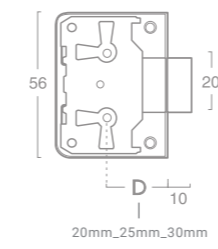

140	90	11	1u.
-----	----	----	-----



KEY "A" INCLUDED_LEVER RIM LOCK
LLAVE "A" INCLUIDA_SOLAPAR
CLEF "A" INCLUE_À SUPERPOSER

TRANSPARENT BLISTERS / ENVASES TRANSPARENTES / COQUES TRANSPARENT

M1

32cm³

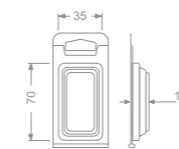

■ 1-M1.80	8423224640098	1550
-----------	---------------	------

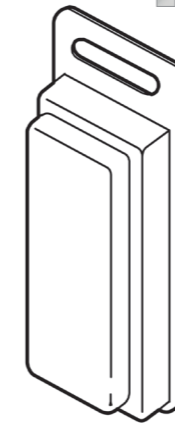

FRONTSIDE CUP
BURBUJA FRONTAL
BULLE FRONTAL

M4

240cm³

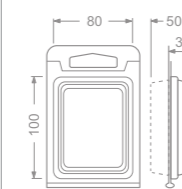

■ 1-M4.80	8423224640128	680
-----------	---------------	-----

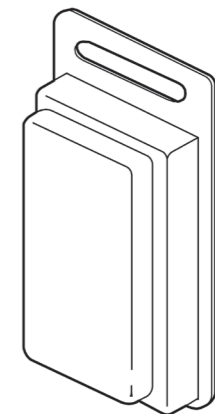

FRONTSIDE CUP
BURBUJA FRONTAL
BULLE FRONTAL

M2 | M3

110cm³ 182cm³

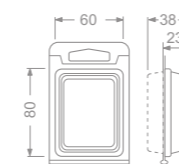

■ 1-M2.80	8423224640104	1000
■ 1-M3.80	8423224640111	950

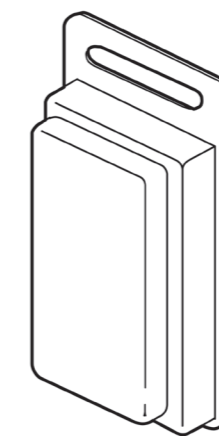

M2

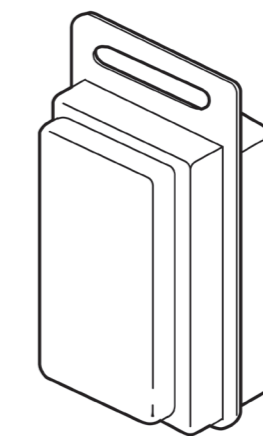

M3

FRONTSIDE CUP
BURBUJA FRONTAL
BULLE FRONTAL



reunionindustrial.com

REUNIÓN INDUSTRIAL S.L.U

Camí L'Horteta, 1 Pol.Ind. 46138 · Rafelbunyol · Valencia · Spain · T. +34 961 414 007